

# 0

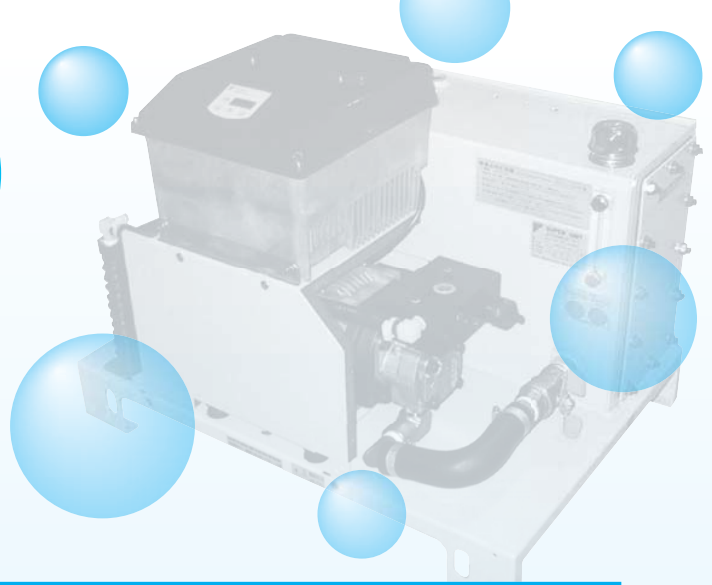

## HYBRID HYDRAULIC

# List of Hybrid Unit Models

Various specifications for each model.  
DAIKIN's lineup provides a variety of functions and capacities depending on the machine type.

4 PQ selection
16 PQ selection
Idle stop
Communication function
Analog command input
Hybrid-Win compatible

		Equivalent to 0.75 kW	Equivalent to 1.5 kW	Equivalent to 2.2 kW	Equivalent to 2.8 kW	Equivalent to 3.7 kW	Equivalent to 5.0 kW	Equivalent to 7.0 kW	Equivalent to 11.0 kW	Equivalent to 15.0 kW minimum
For machine tools	EcoRich	EHU14-L04	EHU25-L04	EHU25-L07	EHU25-M07 EHU30-M07	3.7	5.0	7.0	11.0	15.0 to
	EcoRich R	0.75	1.5	EHU15R-M07	EHU30R-M07	EHU40R-M07	5.0	7.0	11.0	15.0 to
	Super EcoRich	0.75	EHU30S-M075R	2.2	2.8	3.7	5.0	7.0	11.0	15.0 to
For general industrial machines	Unit type	0.75	1.5	SUT03S15L07	SUT03S30L07 SUT03S15L10	SUT03S30L10 SUT03S15L16 SUT06D40L16 SUT10D40L16	SUT06S30L16 SUT06S60L07 SUT06D60L21 SUT10D60L21	SUT10S80L07 SUT10D80L21 SUT16D80L21	P-SUT20D11KW	15.0 to
	Super unit	0.75	1.5	SUT00S1507	SUT00S3007 SUT00S1510	SUT00S4007 SUT00S3010 SUT00S1516 SUT00D4016	SUT00S3016 SUT00S6007 SUT00D6021	SUT00S8007 SUT00D8021	SUT00S11007 SUT00D11021	15.0 to
High-accuracy analog input/output type	Tankless type	0.75	1.5	2.2	2.8	3.7	5.0	SUT00S3018	SUT00S8018 SUT00S5021	SUT00S8021 SUT00S13018 SUT00S13021 SUT00S15018 SUT00S20018

Series	Rated capacity	Maximum operating pressure (MPa)	Maximum flow rate (L/min)											Tankless type	Unit type	Tank capacity (L)	PQ pattern		
			10	20	30	40	50	60	70	80	90	100	110						
EcoRich	Equivalent to 0.75 kW	4.0	[Bar chart]											—	EHU14-L04-A-30	—	1		
	Equivalent to 1.5 kW	4.0	[Bar chart]											—	EHU25-L04-A-30	10			
	Equivalent to 2.2 kW	7.0	[Bar chart]											—	EHU25-L07-AE-30	—			
	Equivalent to 2.8 kW	7.0	[Bar chart]											—	EHU25-M07-AE-30	—			
	Equivalent to 2.8 kW	6.0	[Bar chart]											—	EHU30-M07-AE-30	—			
EcoRich R	Equivalent to 2.8 kW	7.0	[Bar chart]											—	EHU40R-M07-A-10	30	4		
	Equivalent to 2.2 kW	7.0	[Bar chart]											—	EHU15R-M0701-10	10			
	Equivalent to 2.2 kW	7.0	[Bar chart]											—	EHU15R-M0702-10	20			
	Equivalent to 2.8 kW	7.0	[Bar chart]											—	EHU30R-M0701-10	10			
	Equivalent to 2.8 kW	7.0	[Bar chart]											—	EHU30R-M0702-10	20			
Super unit	Single pump type	Equivalent to 2.2 kW	7.0	[Bar chart]											SUT00S1507-10-F/C	SUT03S15L07-10-F/C	30	16	
		Equivalent to 2.8 kW	7.0	[Bar chart]											SUT00S3007-10-F/C	SUT03S30L07-10-F/C			
		Equivalent to 2.8 kW	10.0	[Bar chart]											SUT00S1510-10-F/C	SUT03S15L10-10-F/C			
		Equivalent to 3.7 kW	7.0	[Bar chart]											SUT00S4007-10-F	EHU40R-M07-A-10			
		Equivalent to 3.7 kW	10.0	[Bar chart]											SUT00S3010-10-F	SUT03S30L10-10-F			
	Double pump type	Equivalent to 3.7 kW	16.0	[Bar chart]											SUT00S1516-10-F	SUT03S15L16-10-F	60	4	
		Equivalent to 5.0 kW	16.0	[Bar chart]											SUT00S3016-10-F	SUT06S30L16-20-F			
		Equivalent to 5.0 kW	7.0	[Bar chart]											SUT00S6007-10-F	SUT06S60L07-20-F			
		Equivalent to 7.0 kW	7.0	[Bar chart]											SUT00S8007-10-F/C	SUT10S80L07-10-F/C			100
		Equivalent to 11.0 kW	7.0	[Bar chart]											SUT00S11007-21-F/C	—			—
Super unit (High-accuracy analog input/output type)	Equivalent to 3.7 kW	15.7	[Bar chart]											SUT00D4016-10-F	SUT06D40L16-20-F SUT10D40L16-20-F	60 100	4		
	Equivalent to 5.0 kW	20.6	[Bar chart]											SUT00D6021-10-F	SUT06D60L21-20-F SUT10D60L21-20-F	60 100			
	Equivalent to 7.0 kW	20.6	[Bar chart]											SUT00D8021-10-F/C	SUT10D80L21-10-F/C SUT16D80L21-10-F/C	100 160			
	Equivalent to 11.0 kW	20.6	[Bar chart]											SUT00D11021-21-F/C	P-SUT20D11KW-10	200			
	Equivalent to 7.0 kW	17.6	[Bar chart]											SUT00S3018 (200 V)	—	—	Analog command input		
	Equivalent to 11.0 kW	20.6	[Bar chart]											SUT00S5021 (200/400 V)	—	—			
	Equivalent to 11.0 kW	17.6	[Bar chart]											SUT00S8018 (200/400 V)	—	—			
	Equivalent to 15.0 kW	20.6	[Bar chart]											SUT00S8021 (200 V)	—	—			
Equivalent to 15.0 kW	17.6	[Bar chart]											SUT00S13018 (400 V)	—	—				
Equivalent to 15.0 kW	20.6	[Bar chart]											SUT00S13021 (400 V)	—	—				
Equivalent to 15.0 kW	17.6	[Bar chart]											SUT00S15018 (200/400 V)	—	—				
Equivalent to 22.0 kW	17.6	[Bar chart]											SUT00S20018 (400 V)	—	—				

## EcoRich



### Features

- Achieves a 50% or greater energy saving**  
 (in the pressure retained mode, comparison with Daikin products)  
 Drastic energy savings are realized by reducing the motor rotation speed in pressure retained operation.  
 Our original highly efficient SR motor, controller and compact fixed-displacement pump are mounted.
- High-speed response**  
 Combination of special SR motor, which has low rotation inertia and generates high torque at low rotation speed, and high-speed response inverter  
 Response equivalent to or higher than conventional variable displacement pumps (Pressure retained operation ⇔ operation at maximum flow rate: 0.1 sec or less)

### Nomenclature

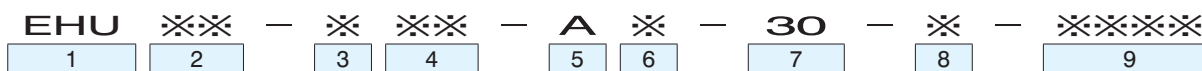

**1 Model No.**

EHU: EcoRich EHU series

**2 Pump maximum flow rate**

14: 14 L/min  
 25: 25 L/min  
 30: 28.5 L/min

**3 Output characteristic (Refer to the output characteristic diagram in the pressure – flow rate characteristics section.)**

L:  
 M:

**4 Maximum operating pressure**

04: 4.0 MPa  
 07: 7.0 MPa (6.0 MPa with some models)

**5 Control method**

A: Pressure compensated control

**6 Specifications of controller**

No code: (In case of EHU14-L04, EHU25-L04)  
 Without reactor  
 E: (In case of EHU25-L07/M07, EHU30-M07)  
 With reactor

**7 Design No.**

(May change according to model changes.)

**8 Option symbol**

No code: With fixed relief valve  
 V: With variable relief valve

**9 Non-standard No.**

No code: Standard

## Specifications

### [Main specifications]

Model	Motor capacity (Nominal)	Tank capacity (L)	Maximum operating pressure (MPa)	Maximum flow rate (L/min)	Mass (kg)
EHU14-L04	Equivalent to 0.75 kW	10	4.0	14.0	43
EHU25-L04	Equivalent to 1.5 kW			25.0	
EHU25-L07	Equivalent to 2.2 kW				
EHU25-M07	Equivalent to 2.8 kW				
EHU30-M07	Equivalent to 2.8 kW		6.0	28.5	46

- Notes
- Maximum flow rate in continuous operation at maximum operating pressure:  
 • EHU14: 5 L/min • EHU25: 5 L/min • EHU30: 5 L/min
  - The minimum setting for the PC (pressure compensator) pressure is 1.5 MPa. If the PC pressure is adjusted, it is necessary to reset the minimum rotational speed and to set the pressure at the safety valve to the PC pressure + 0.5 MPa. (With EHU40R, the safety valve is adjusted to 7.5 MPa, and therefore, no adjustment is necessary even when a low PC pressure is set. For details, refer to the Instruction Manual provided separately.)
  - If a bigger tank capacity and higher pressure are required, please use a Super Unit (SUT).

### [Rated current]

Model	Rated current (A)			No-fuse breaker setting (A)
	200 V 50 Hz	200 V 60 Hz	220 V 60 Hz	
EHU14-L04	7.3	7.3	7.0	15
EHU25-L04	7.9	7.9	7.5	
EHU25-L07	5.7	5.7	5.3	
EHU25-M07	9.1	9.1	8.5	
EHU30-M07	9.6	9.6	8.7	

- Notes
- Use electric wires with a gauge equivalent to AWG14 (2.0 to 2.5 mm<sup>2</sup>) for power supply connections.
  - EcoRich is equipped with an inverter that incorporates the internal overcurrent protection function and therefore no thermal relay for overcurrent protection is required for EcoRich. If you use a thermal relay, it may malfunction due to the switching operation of the inverter.
  - Power supply voltage: 200 V (50 Hz), 200 V (60 Hz), 220 V (60 Hz), Permissible power-supply voltage fluctuation: ±10%

### [Alarm/External input signal]

Model	Alarm signal	External input signal
EHU14-L04	COM-ALMa: Normally closed, opened on occurrence of an error	Motor run/stop
EHU25-L04	COM-ALMa: Normally open, closed on occurrence of an error	
EHU25-L07	Alarm contact switching capacity: DC 24 V, 0.5 A (minimum load current 10 mA)	
EHU25-M07	(at resistance load)	
EHU30-M07		

- Notes
- The motor can be started or stopped by turning the external input signal (DIN0) on and off. (Use an external power supply with a capacity of DC 24±1 V, 0.5 A or greater.)
  - EHU40R-M07 has two terminals, DIN1 and DIN2, for external input signals, in addition to the signals indicated, to enable selection of the pressure and flow rate settings from among four internal preset patterns (PQ selection).
  - Use electric wires with a gauge equivalent to AWG22 (0.3 sq) for alarm and external input signal connections.

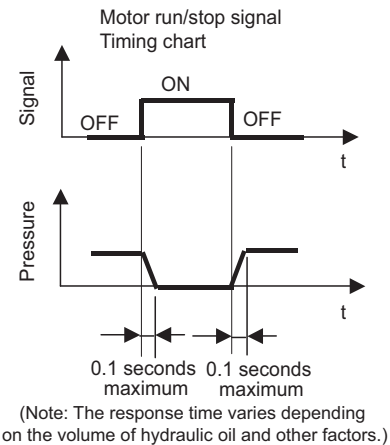

## Pressure – Flow rate characteristics

### Output characteristic (P-Q characteristic)

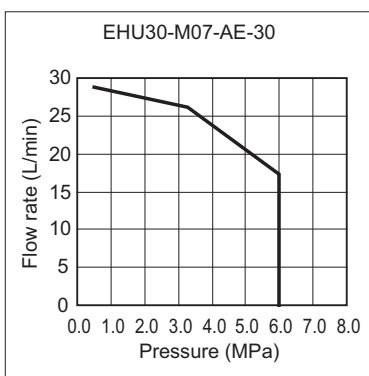
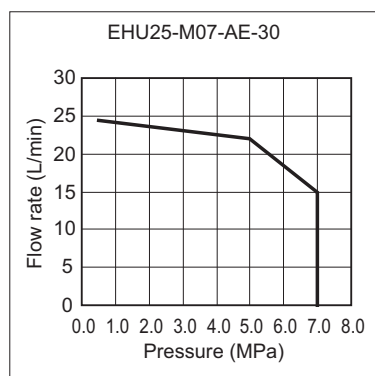
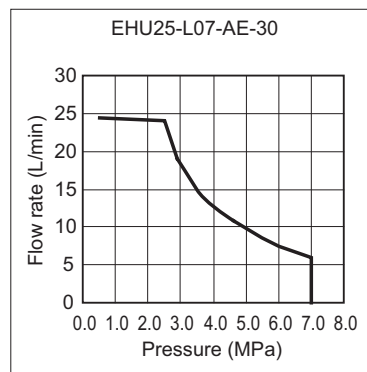
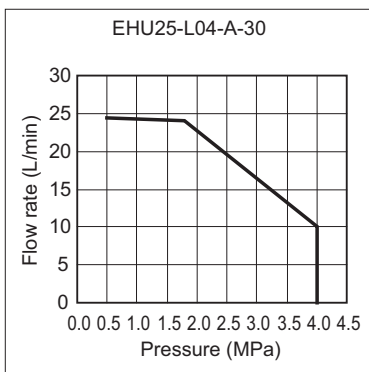
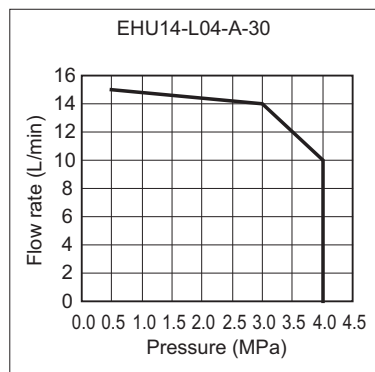

### Detail of terminal box (EHU14, 25, 30)

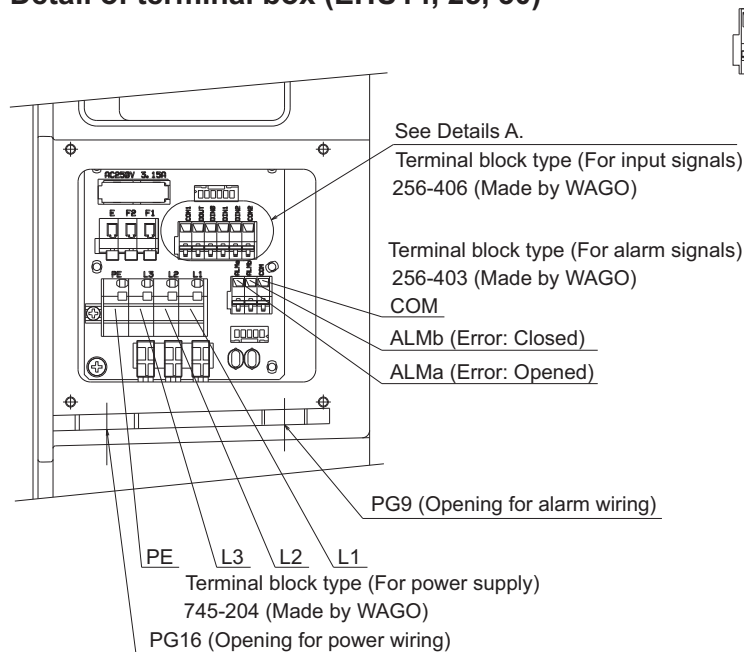

Wiring layout in the controller

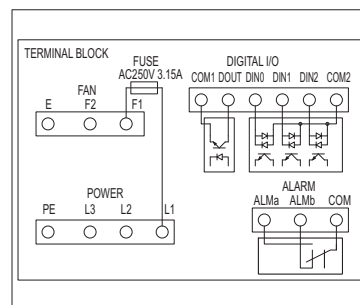
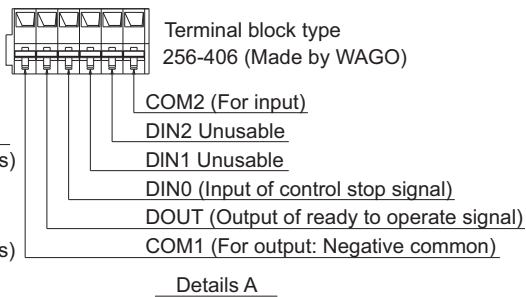

Wiring diagram

## Optional parts (For EcoRich and EcoRich R)

### Level switch

Model	Operation voltage	Maximum operation current	Contact resistance	Protection class	Alarm for oil temperature and action		CE standard	Applicable model
E-DLSN-130L-A-10	DC 24 V	0.05 A	1 Ω maximum	IP65	EHU14/25/30 (with 10 L tank)	7.3 L or less	N/A	<ul style="list-style-type: none"> <li>•Directly mountable on EHU14-L04 (0.75 kW) to EHU30-M07 (2.8 kW) at drain port DR2 (Rc1/2)</li> <li>•Mountable on EHU15R/30R (with 20 L tank) at drain port DR2 (Rc3/4) with a bushing (3/4 × 1/2)</li> <li>•Directly mountable on the EHU40R-M07 super unit at the option port (Rc1/2)</li> </ul>
E-DLSN-130L-B-10					EHU15R/30R (with 20 L tank)	13 L or less		
E-DLSN-90L-A-10	DC 24 V	0.05 A	1 Ω maximum	IP65	EHU15R/30R (with 10 L tank)	7.2 L or less	N/A	<ul style="list-style-type: none"> <li>•Mountable on EHU15R/30R (with 10 L tank) at drain port DR2 (Rc3/4) with a bushing (3/4 × 1/2)</li> </ul>
E-DLSN-90L-B-10								

### Temperature switch

Model	Operation voltage	Maximum operation current	Contact resistance	Protection class	Alarm for oil temperature and action		CE standard	Applicable model
E-MQT83PD-L60X1-10	100 VAC 24 VDC	2 AAC 50 mADC	30 mΩ maximum	IP65	Temperature rise over 60°C Temperature differential from 7 to 13°C	Open	N/A	<ul style="list-style-type: none"> <li>•Mountable on EHU14-L04 (0.75 kW) to EHU30-M07 (2.8 kW) at drain port DR1 (Rc1) with a bushing (1 × 3/8) or DR2 (Rc1/2) with a bushing (1/2 × 3/8)</li> <li>•Mountable on EHU15R/30R at drain port DR2 (Rc3/4) with a bushing (3/4 × 3/8)</li> <li>•Directly mountable on the EHU40R-M07 super unit at the option port (Rc3/8)</li> </ul>
E-MQT83PD-L60X1-1-10								

## Handling

### ● Ambient conditions

1. Ambient temperature: 0 to 35°C, Ambient humidity: 20 to 85% RH, Altitude: 1,000 m maximum, To be used indoors

### ● Hydraulic oil

1. Mineral-oil base hydraulic oil should be used.  
Use of other hydraulic oils (e.g. hydrous/synthetic) is prohibited.
2. Use hydraulic oil equivalent to ISO VG32 to 68 and operate the unit within an oil viscosity range from 15 to 400 mm<sup>2</sup>/s and a tank oil temperature from 0 to 60°C.
3. Oil cleanliness should be within NAS class 10.

### ● Installation and piping

1. To transport EcoRich, use eyebolts at the top of the unit.  
Attach the bolt and spacer for protecting the rubber vibration isolator. If transportation is undertaken without the bolt and spacer, the rubber vibration isolator may be damaged and the EcoRich may fall. Take care not to subject the unit to strong impact due to dropping or a collision during transportation.
2. The unit is a stationary type. Fix it with bolts on a level location that is free of vibration.
3. Do not place any obstacles to oil cooler air intake and exhaust within a distance of 100 mm from intake and exhaust vent of the motor and the oil cooler. Install the unit at a location with good air flow so that heated air can be vented.
4. Use hoses for piping to provide flexibility.
5. Before operating the unit, be sure to remove the bolt and spacer for protecting the rubber vibration isolator. If you fail to do so, the noise and vibration may be excessive.

### ● Electric wiring

1. When the wire is connected from the power source, the required protectors should be installed and the wiring must conform to the applicable laws, regulations, and standards. (For example, the unit should be equipped with an electric circuit conforming to European Standard EN60204-1 to protect electrical circuits from over current, in the event of short circuits for example, and to protect the control unit from overloading.)  
The unit should be equipped with an earth leakage breaker to prevent electric shock and other hazards.
2. Securely connect wires with appropriate gauges in accordance with the wiring diagram on the back of the terminal cover. Be sure to provide a ground connection with a grounding resistance of 100 Ω maximum.
3. Use a commercial power supply for the power source. The use of an inverter power supply may cause burn damage to the unit.

### ● Other precautions

1. If a failure occurs in the hydraulic unit, the system indicates an alarm and terminates.
2. If a failure or malfunction of this unit is expected to cause death or pose a danger to human beings, adopt appropriate safety measures in the facilities. If this unit is applied in an important facility, also adopt appropriate safety measures in the facility to ensure that a failure of the equipment will not lead to a serious accident or loss.
3. It takes 5 to 13 seconds for this hydraulic unit to start up after being switched on. During this time, the alarm signal circuit is open. This is not abnormal.
4. Do not turn the main power supply ON/OFF frequently to stop the unit. It may damage inverter components.

## EcoRich R

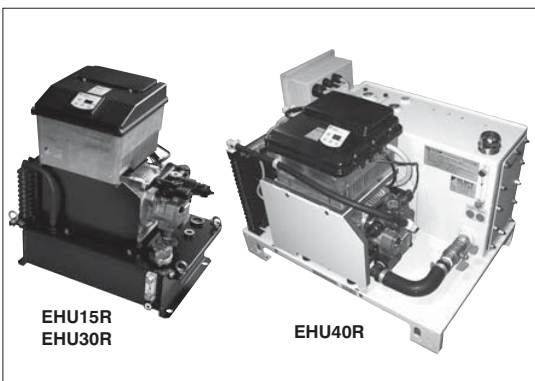

### Features

- 60% reduction of power consumption** (in the pressure retained operation, comparison with Daikin products)  
 Further energy saving with high-efficiency IPM motor drive system installed.
- 4-patterns PQ selection function**  
 Four patterns of pressure and flow rate settings can be set at the operation panel on the unit.  
 The pressure and flow rate settings selected from among the four patterns can be changed with external input signals.
- Dry run prevention function (for operation when oil level is low.)**  
 The unit incorporates the dry run prevention function to automatically stop operation when the oil level in the tank drops lower than a certain level. This prevents the pump from running while dry and helps to extend the service life.
- Improved pressure control performance range**  
 A pressure setting at 0.5 MPa is now possible.
- Optional functions**  
 Provision of a terminal box: Enables easy electrical wiring.  
 Temperature-rise function: Raises the oil temperature in a shorter time from a low temperature and enables the warm-up operation for the machine to be shortened.

### Nomenclature

EHU
※※
R
-
M
※※
※※
※
※
-
10
-
※※※

- |   |  |  |                                  |
|---|--|--|----------------------------------|
| <p><b>1 Model No.</b><br/>EHU※※R: EcoRich R</p> <p><b>2 Pump maximum flow rate (discharge rate)</b><br/>15: 15.2 L/min<br/>30: 28.5 L/min</p> <p><b>3 Maximum operating pressure</b><br/>M07: 7.0 MPa</p> | <p><b>4 Tank capacity</b><br/>01: 10 L<br/>02: 20 L</p> <p><b>5 Hardware option</b><br/>No code: Without terminal box<br/>B: With terminal box</p> | <p><b>6 Function option</b><br/>No code: 4-pattern pressure-flow rate (PQ) selection<br/>Without heating function<br/>T: 4-pattern pressure-flow rate (PQ) selection<br/>With heating function</p> <p><b>7 Design No.</b><br/>(May change according to model changes.)</p> | <p><b>8 Non-standard No.</b></p> |
|---|--|--|----------------------------------|

EHU
40
R
-
M
07
A
-
10
-
※※※

- |  |  |  |
|--|--|--|
| <p><b>1 Model No.</b><br/>EHU※※R: EcoRich R</p> <p><b>2 Pump maximum flow rate (discharge rate)</b><br/>40: 40.0 L/min</p> | <p><b>3 Maximum operating pressure</b><br/>M07: 7.0 MPa</p> <p><b>4 Control method</b><br/>A: Pressure compensated control</p> | <p><b>5 Design No.</b><br/>(May change according to model changes.)</p> <p><b>6 Non-standard No.</b></p> |
|--|--|--|

## Specifications

Model code	EHU15R-M0701	EHU15R-M0702	EHU30R-M0701	EHU30R-M0702	EHU40R-M07-A
Maximum operating pressure (MPa)	7.0				
Operating pressure adjustment range (MPa)	0.5 to 7.0				1.5 to 7.0
Maximum flow rate <sup>*1</sup> (L/min)	15.2		28.5		40.0
Operating flow rate range (L/min)	2.5 to 15.2		3.5 to 28.5		5.3 to 40.0
Motor capacity (kW)	Equivalent to 2.2 kW		Equivalent to 2.8 kW		Equivalent to 3.7 kW
Tank capacity (L)	10	20	10	20	30
Power supply	3-phase, AC 200 V (50 Hz), AC 200 V (60 Hz), AC 220 V (60 Hz) (Permissible voltage fluctuation: ±10%)				
External input signal	3 channels, photo coupler insulation, DC 24 V, (Maximum of DC 27 V), 5 mA per channel				
External output signal	Digital output	2 channels, photo coupler insulation, open collector output, DC 24 V, 30 mA maximum per channel			
	Contact output	1 channel, relay output, Contact capacity: DC 30 V, 0.5 A (Resistance load), 1 common contact			
Rated current	200 V (50 Hz) (A)	7.9	10.9	11.2	
	200 V (60 Hz) (A)	7.7	10.7	10.9	
	220 V (60 Hz) (A)	7.1	9.7	10.0	
No-fuse breaker capacity (A)	15				20
Mass (hydraulic oil excluded) (kg)	39	40	41	42	68
Standard coating color	Black (Munsell code N1)				Ivory white (Munsell code 5Y7.5/1)
Usable oil <sup>*2</sup>	Mineral-oil base special hydraulic oil/wear resistance hydraulic oil • Viscosity grade: ISO VG32 to 68 • Viscosity range: 15 to 400 mm <sup>2</sup> /s • Volumetric water content: 0.1% maximum • Contamination: Within NAS class 10				
Oil temperature in tank	0 to 60°C (Recommended operating temperature range: 15 to 50°C)				
Operating ambient temperature	0 to 35°C				
Storage ambient temperature	-20 to 60°C				
Humidity	85% RH maximum (No condensation)				
Installation site	Indoors (Be sure to secure with bolts, etc.)				
Altitude	1,000 m maximum				

- \* 1 • The maximum flow rate is the theoretical value, not the guaranteed value.
- Refer to the Delivery Specification (outside drawing) for detailed specifications.
- This hydraulic unit is equipped with built-in safety valves.

- \* 2 Use of hydraulic oils other than mineral-oil base type (e.g. hydrous/synthetic), water-glycol hydraulic oil for example, is prohibited.

## Pressure – Flow rate characteristics

EHU15R-M0701/EHU15R-M0702

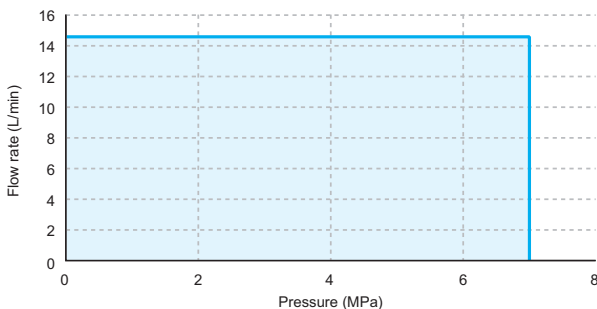

EHU30R-M0701/EHU30R-M0702

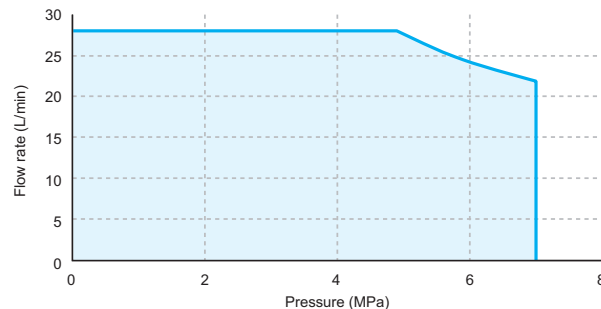

EHU40R-M07-A

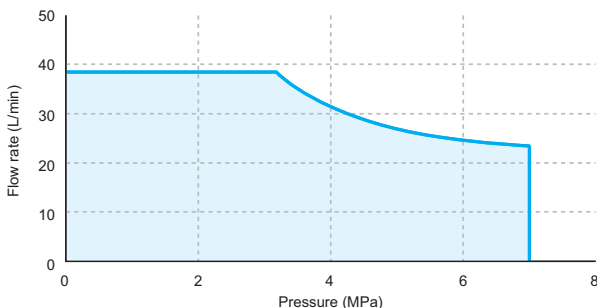

\* Showing the representative characteristics with a power supply of 200 V at 60 Hz and an oil temperature of 40°C



## Handling

### ● Ambient conditions

1. Ambient temperature: 0 to 35°C, ambient humidity: 20 to 85% RH, altitude: 1,000 m maximum, to be used indoors

### ● Hydraulic oil

1. Use mineral-oil base hydraulic oil.  
Use of hydraulic oils other than mineral-oil base type (e.g. hydrous/synthetic) is prohibited.
2. Use hydraulic oil equivalent to ISO VG32 to 68. Keep the viscosity of the hydraulic oil within the range between 15 and 400 mm<sup>2</sup>/s, and keep tank oil temperatures within the range between 0 and 60°C.
3. Keep contamination of hydraulic oil within NAS class 10.

### ● Installation and piping

1. EcoRich R mounts the motor pump using vibration-absorbing rubber to prevent vibration of the motor pump from being transmitted to the unit.  
Use hoses for piping to the unit to provide flexibility.
2. The unit is a stationary type. Fix it with bolts on a level location that is free of vibration.
3. Do not place any obstacles to oil cooler air intake and exhaust within a distance of 100 mm from intake and exhaust vent of the motor and the oil cooler.  
Install the unit at a location with good air flow so that heated air can be vented.

### ● Electric wiring

1. Install a no-fuse breaker and a ground fault interrupter compliant with European Standard EN60947-2 in the main power supply of EcoRich R, to protect the electrical circuits against shorting and overcurrent, and to prevent electric shocks.
2. Use suitable electric cable in accordance with the power supply capacity .
3. Be sure to provide a ground connection with a grounding resistance of 100 Ω maximum, and connect the grounding wire directly with no breaker in the line.
4. Take care not to leave waste metal such as screws and cutting chips, combustible matter such as wood waste or oil, or wiring debris inside the controller.
5. Use a commercial power supply for the power source. The use of an inverter power supply may cause burn damage to the unit.

### ● Other precautions

1. If a failure occurs in the hydraulic unit, the system indicates an alarm and stops. If a failure or malfunction of this unit is expected to cause death or pose a danger to human beings, adopt appropriate safety measures in the facilities.  
If this unit is applied in an important facility, also adopt appropriate safety measures in the facility to ensure that a failure of the equipment will not lead to a serious accident or loss.
2. EcoRich R mounts an IPM motor, which generates a counter-electromotive force during switching operation (regenerative operation).  
Frequent switching under operating conditions that are likely to generate a counter-electromotive force may cause overloading of regenerative operation, which may cause the unit to stop.

# ***DAIKIN INDUSTRIES, LTD.***

Oil Hydraulic Equipment

Osaka Office

YODOGAWA PLANT

1-1, Nishi-Hitotsuya, Settsu, Osaka 566-8585, Japan

Indian Representative

Technocrats Alliance Engineering Pvt. Ltd.

**Works/Correspondence Office** : 11/23, TIL Compound, Site-IV,  
Sahibabad Industrial Area, Ghaziabad - 201010 (UP) INDIA

**Registered Office** : C - 12 / 333, Yamuna Vihar, Delhi - 110053 INDIA

Tel: +91-11- 42448311, 22448312 Fax: +91-11-4248312

E-mail : [info@tca.co.in](mailto:info@tca.co.in) website : [www.tca.co.in](http://www.tca.co.in)